

 **BPC** BESPOKE  
PLASTER  
CRAFT

ARTISAN IN PLASTER

Our production team can manufacture special designs to suit many different architectural and decorative styles.

We have a specialist craftsmen with years of experience in the industry. Our extensive knowledge has given us the experience and the competence, so we are able to offer high quality solutions.

We are able to manage and realize any services on request anywhere around the world.





CORNICE MOULDINGS

---

7



BRACKETS

---

25



DOMES & NICHES

---

33



PANELS MOULDINGS

---

15



FIRE PLACE MOULDINGS

---

27



COLUMNS & PILASTERS

---

35



ROSE MOULDINGS

---

21



DECORATIVE MOULDINGS

---

29

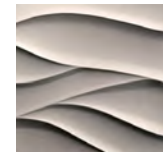

3D PANELS

---

39





## CORNICE MOULDINGS



CM1

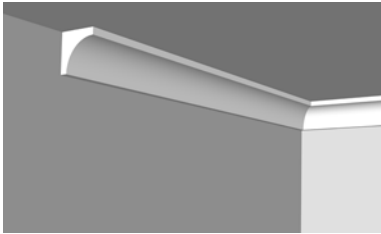
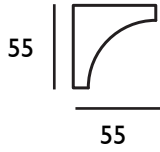

CM4

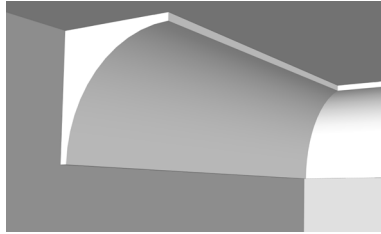
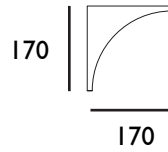

CM7

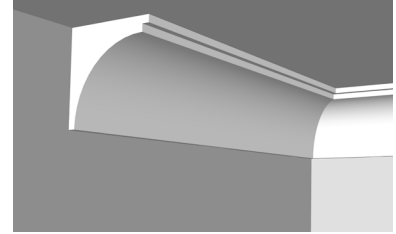
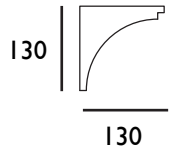

CM2

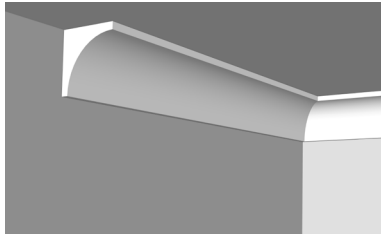
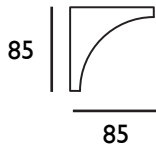

CM5

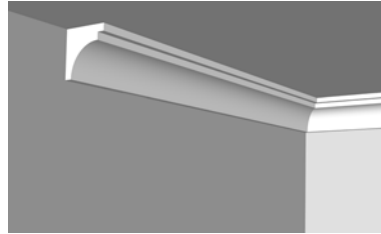
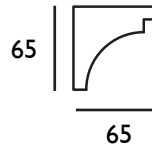

CM8

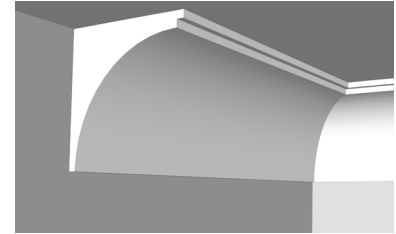
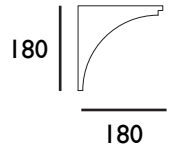

CM3

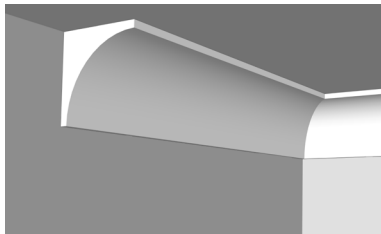
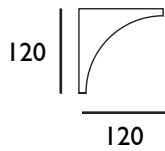

CM6

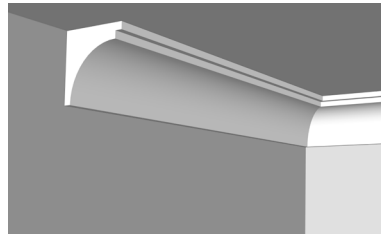
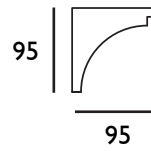

CM9

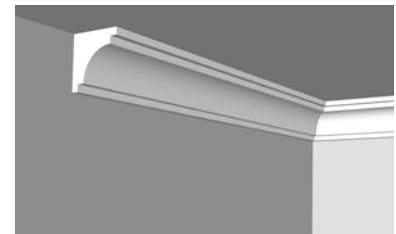
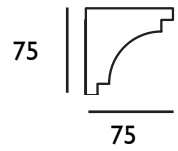

CM10

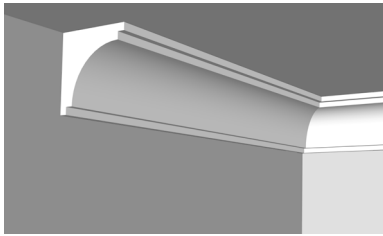
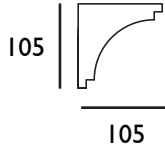

CM11

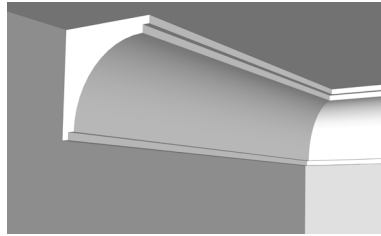
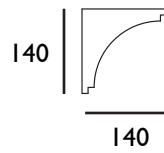

CM12

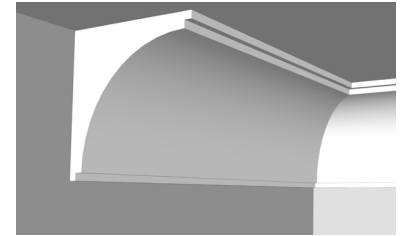
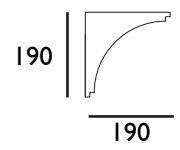

CM13

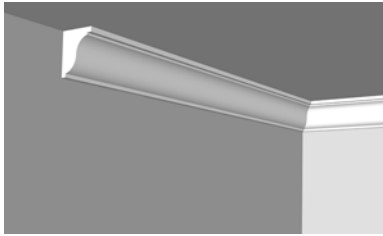
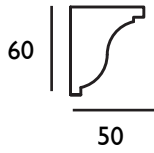

CM14

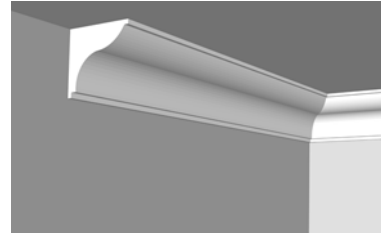
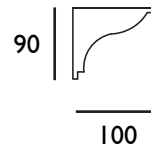

CM15

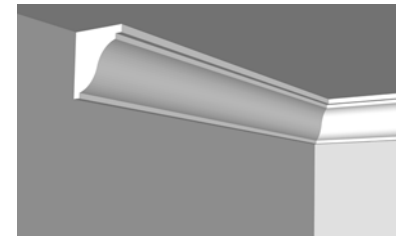
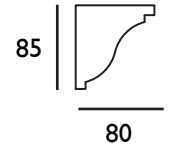

CM16

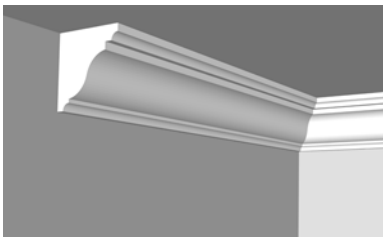
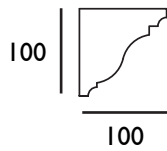

CM17

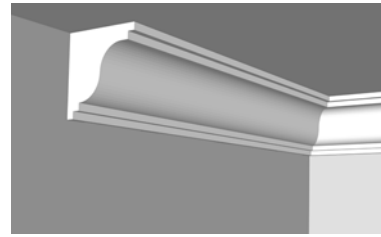
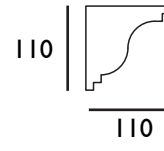

CM18

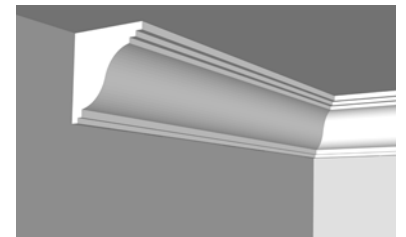
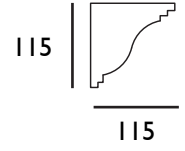

CM19

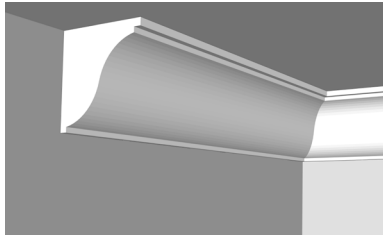
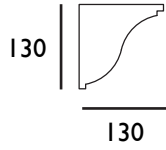

CM20

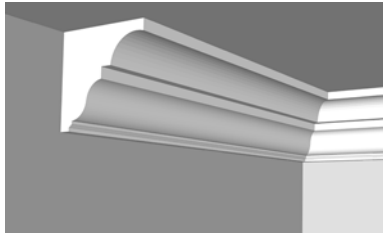
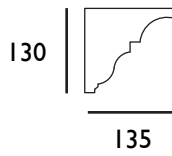

CM21

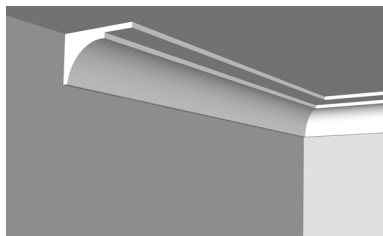
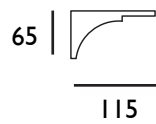

CM22

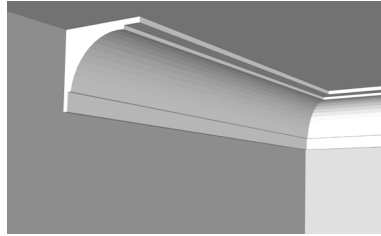
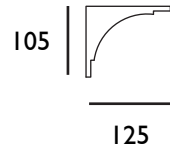

CM23

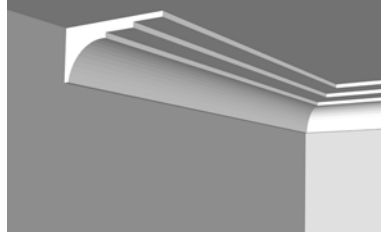
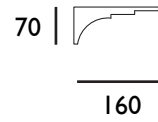

CM24

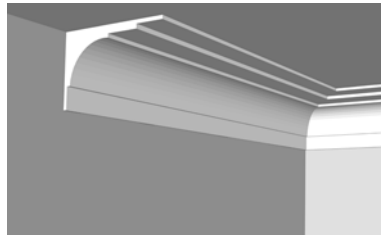
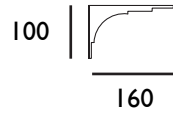

CM25

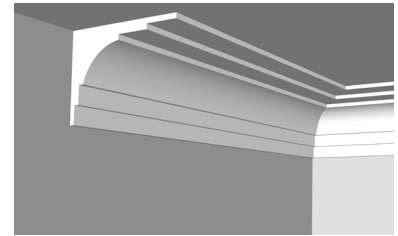
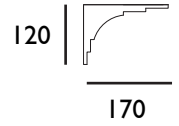

CM26

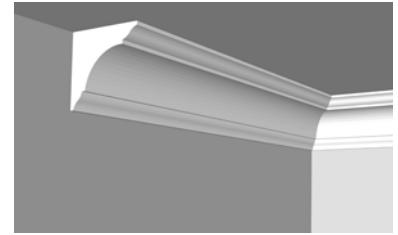
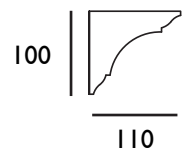

CM27

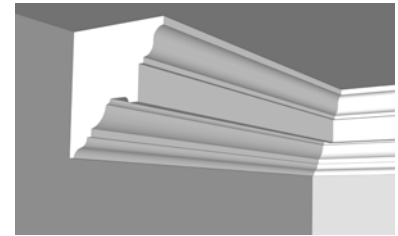
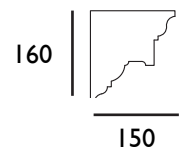



CM28

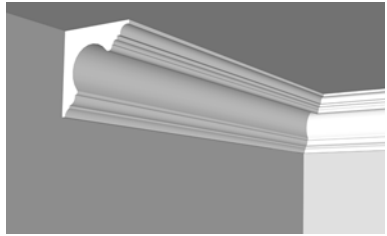
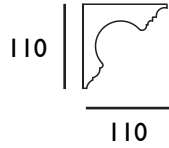

CM29

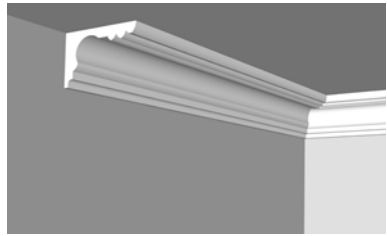
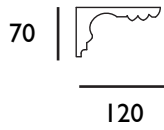

CM30

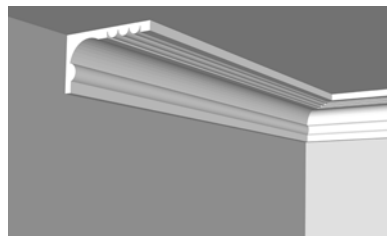
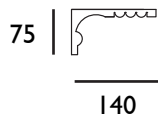

CM31

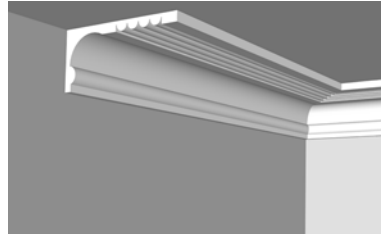
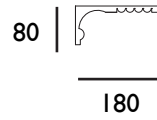

CM32

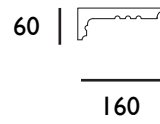

CM33

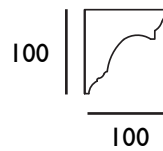

CM34

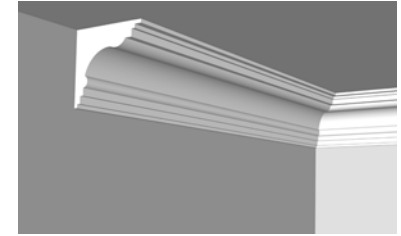
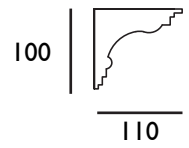

CM35

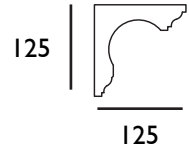

CM36

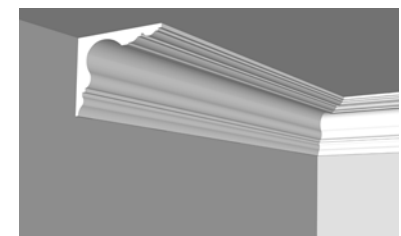
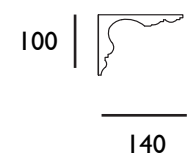

CM37

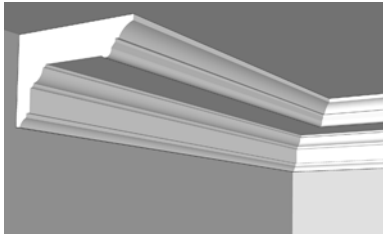
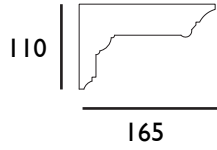

CM40

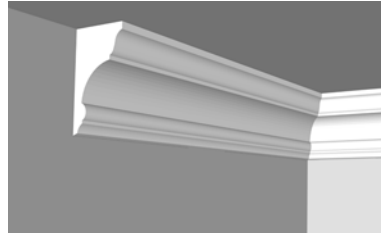
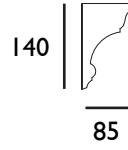

CM43

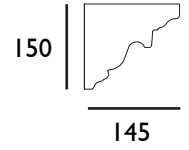

CM38

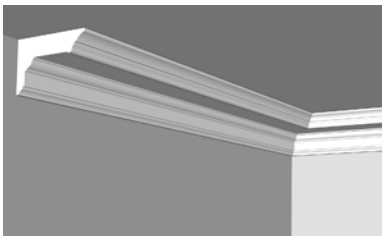
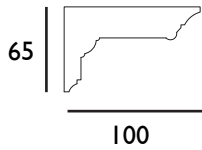

CM41

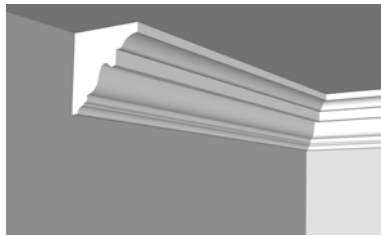
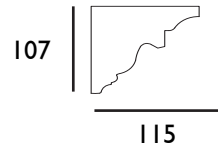

CM39

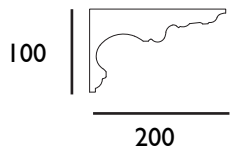

CM42

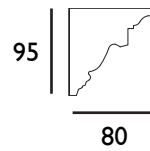

CM44

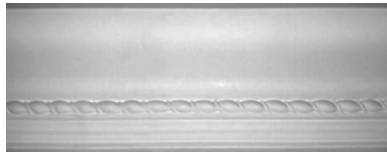

80



100

CM47



75

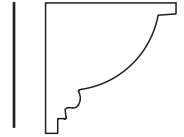

70

CM45



55

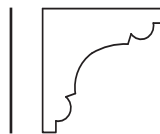

65

CM48

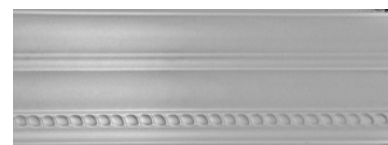

70

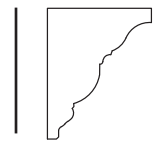

70

CM46



126



126

CM49

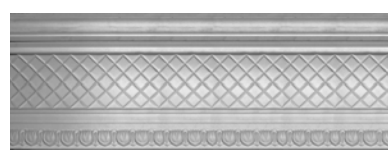

161



156

CM50

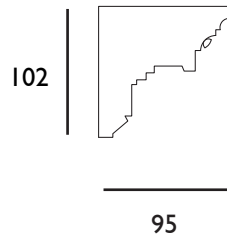

CM53

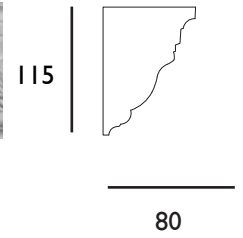

CM51

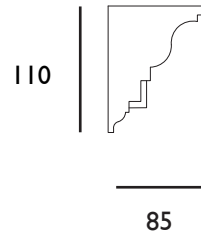
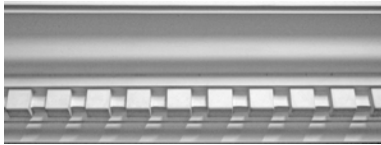

CM54

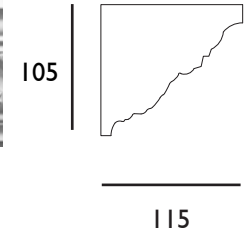

CM52

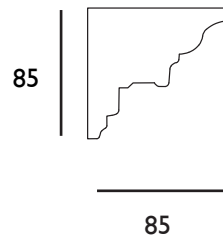
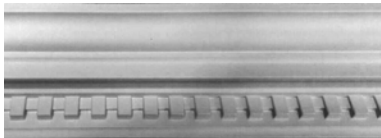

CM55

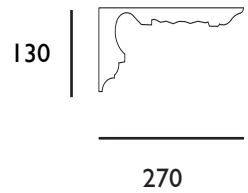



## PANELS MOULDINGS



PM1



110



235

PM4

To combine with PM1



43



9

L2600

PM2



260



260

PM5

To combine with PM2 and PM3



49



25

L2000

PM3



210



208

PM6



65

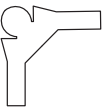

65

L2600, corner bit

PM7



255



255

PM10

To combine with PM7



40



L2000

19

PM8



270



270

PM11



66



20

PM9



320



320

PM12

To combine with PM9



90



L2000

16

PM13



L2000

80



45

PM16

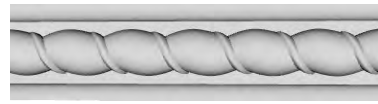

L2000

33



17

PM14

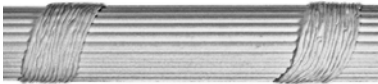

L2000

57



30

PM17



L2000

60



PM15



L2000

120

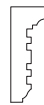

45

PM18



L2000

148





PM18

---

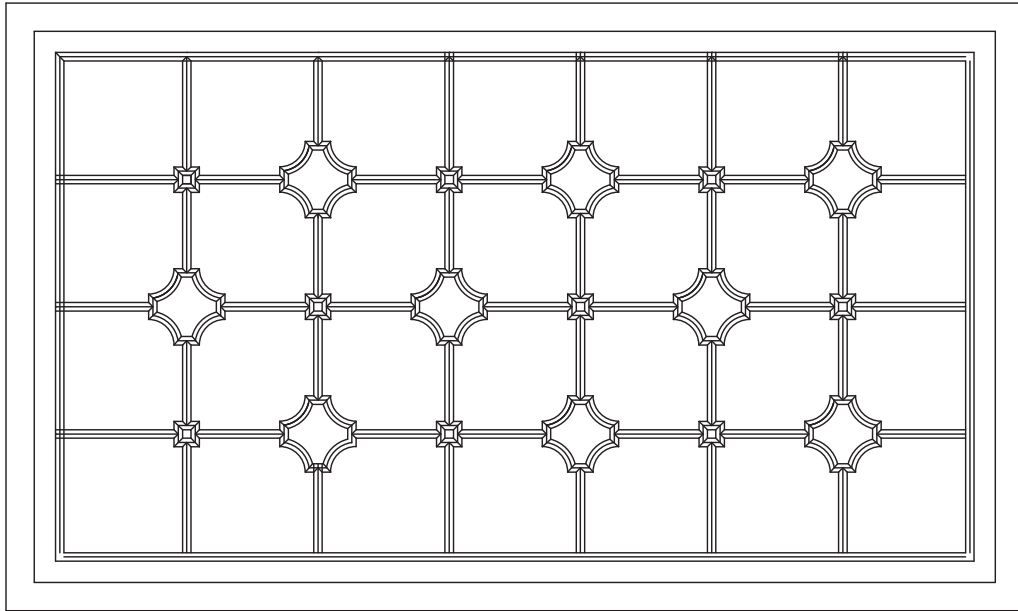





## ROSE MOULDINGS



RM1

---



RM1

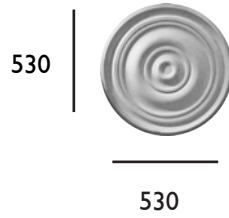

RM2

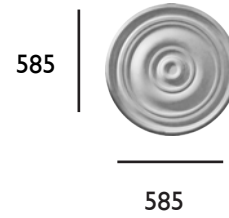

RM3

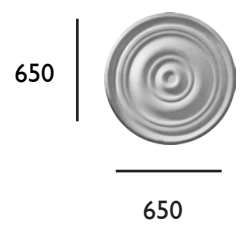

RM4

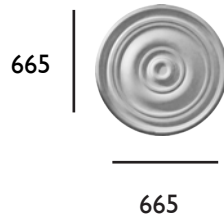

RM5

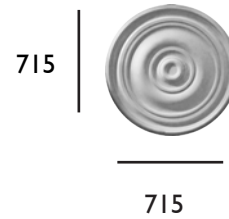

RM6

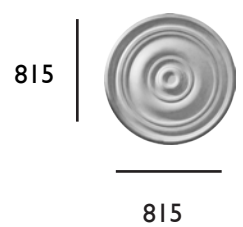

RM7

---



RM7

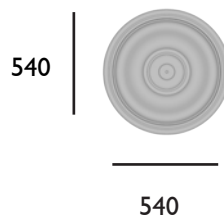

RM8

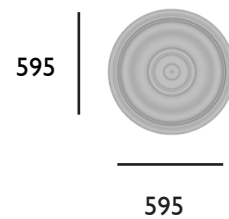

RM9

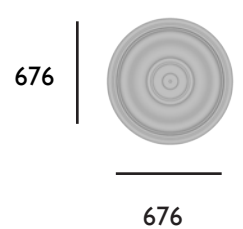

RM10

---

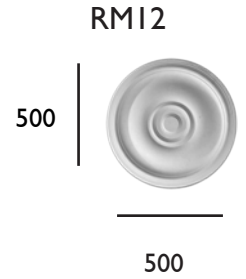
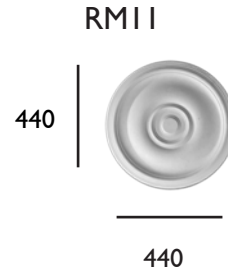
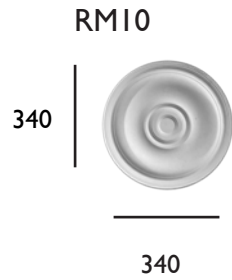

RM13

---

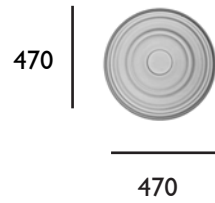

RM15

---

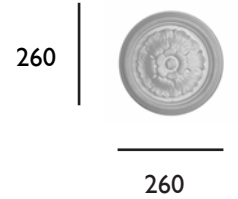

RM14

---

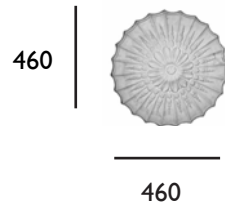

RM16

---

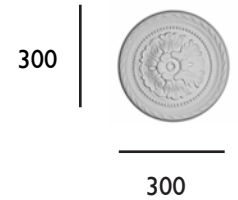

RM17



305



305

RM20



820



820

RM18



380



380

RM21



510



510

RM19



770



770

RM22



767



532



## BRACKETS MOULDINGS



BM1

---



BM4

---



BM2

---



BM3

---







FIRE PLACE MOULDINGS

---

FPM1



1100



595

880

1050

FPM4



1365



840

900

1150

FPM2



1145



860

895

1305

FPM5



1390



880

820

1235

FPM3



1215



850

760

1130

FPM6



1360



920

810

1110



## DECORATIVE MOULDINGS



DM1



100



100

DM4



110



85

65

DM2



25



24

DM5



75



75

DM3



410



270

DM6



80

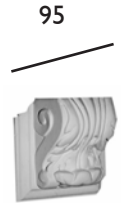

95

50

DM7

---



795



---

415

DM8

---



360



---

945





## DOMES & NICHES



NI

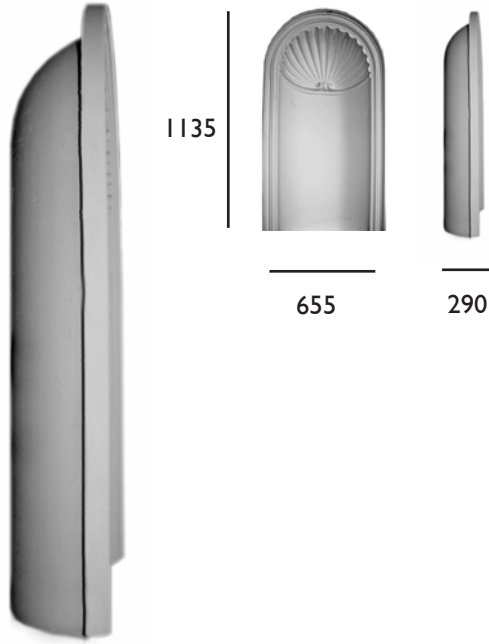

DI

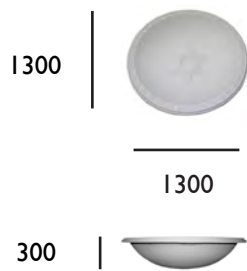

D2

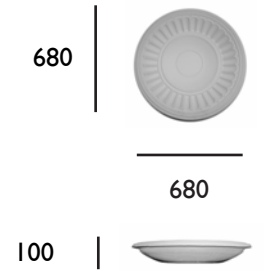





FULL COLUMNS

---

FC1

100



1962

204

FC2

125



2300

250

FC3

125



2345

250

FC4

152



2300

304

FC1b



110

130

260

FC2b, FC3b



170

190

425

FC4b



170

425

FC1a

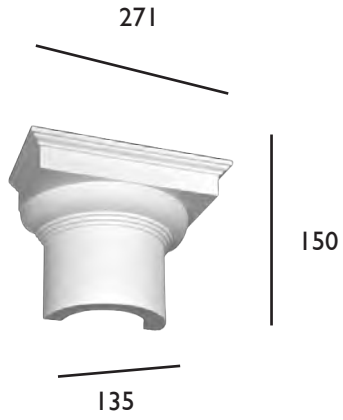

FC2a

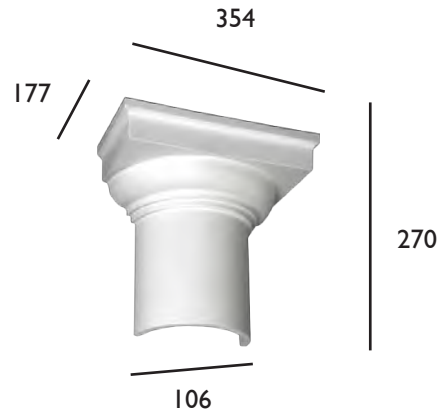

FC2c

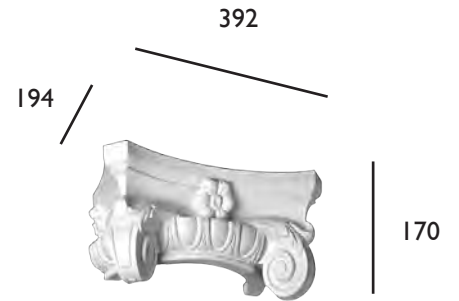

FC3a



FC4a



FC2d

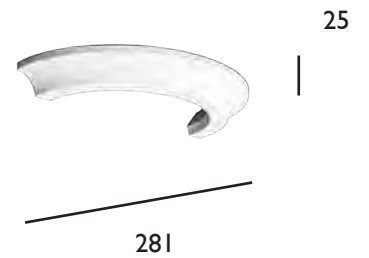



## GLASS REINFORCED GYPSUM

We are able to produce bespoke GRG  
products



## 3D PANELS



### 3D1



600



600



### 3D2



500



500



### 3D3

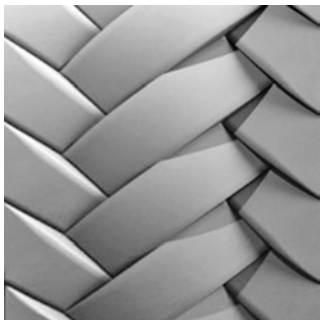

500

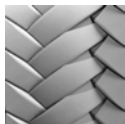

500

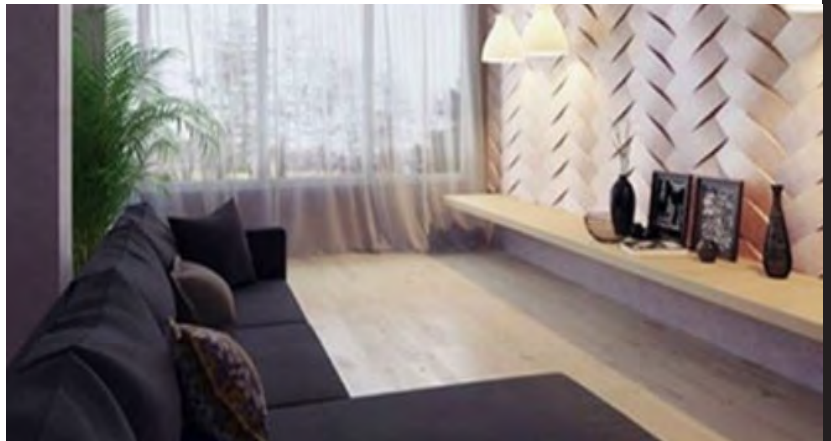

3D4

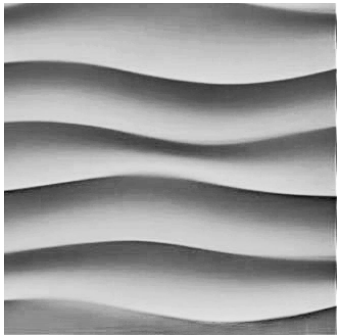

500

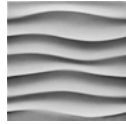

500



3D5

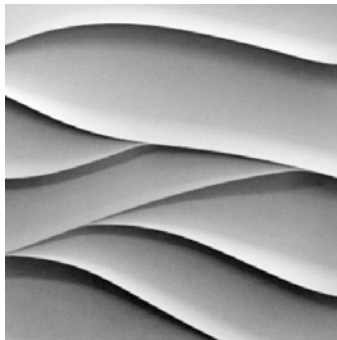

500

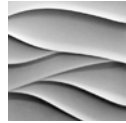

500



3D6

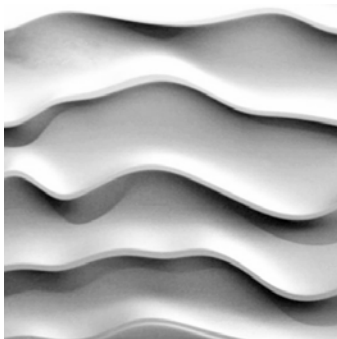

500

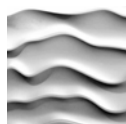

500







Knowledge, Experience & High Quality Solutions  
Absolutely Stunning Design & Functionality

BPC, Bespoke Plaster Craft,  
Unit 1A, Chapel Lane, Westcott, Dorking RH4 3PJ  
info@bpcdirect.co.uk, Tel. +44 1372 80 2364, web: www.bpcdirect.co.uk